

# Fuzzy Logic Control of Clutch for Hybrid Vehicle

Vu Trieu Minh  
Mechanosystem - Department of Mechatronics  
Tallinn University of Technology  
trieu.vu@ttu.ee

**Abstract** — This paper provides a design of an automatic clutch controller for hybrid electrical vehicle (HEV) using fuzzy logic. The use of fuzzy logic can reduce the difficulty of mathematical modeling of complex systems since fuzzy logic can deal with uncertain and imprecise data and problems which may have several solutions rather than one. Fuzzy logic algorithms for the automatic clutch controller are developed to achieve a smooth and fast engaging transition. Comprehensive simulations for the whole hybrid electrical vehicle are conducted in Matlab 2009a. An experimental test for a real damping clutch is also carried out. Results show that the active regulation of the clutch slipping ration can considerably reduce the vehicle vibration in resonance frequencies. The new system can handle the clutch engagement with low jerk and high comfort.

## I. INTRODUCTION

This paper is a modified version of a paper submitted and printing in Journal of Systems and Control Engineering [1]. The idea for the automatic clutch controller of hybrid electrical vehicles is that a dry-plate friction clutch in manual transmission always provides higher transmission efficiency (97%) than a wet clutch (torque converter) in automatic transmission (86%). If an automatic controller for a dry-plate friction clutch can be successfully installed and the clutch pedal can be eliminated from the vehicle, the driver can treat the new system like a normal automatic transmission.

Since the dry friction clutch is always the most efficient transmission available and much cheaper than the torque converter in automatic transmission vehicles, this paper develops an automatic controller for this simple dry friction clutch. Some other obvious advantages of the new system including the reduction of noise and vibration are also investigated.

In the parallel hybrid vehicle, the primary power source, an internal combustion engine (ICE) and the secondary power source, an electrical motor (EM) are independently installed so that both can separately or together propel the vehicle. Typically the control of the transitional engagement between EM and ICE are based on the heuristic knowledge on the characteristics of the ICE and EM [2]. For comfort and safety reasons, several control approaches for smothering the engagement of clutches have been developed including back stepping control [3], optimal control [4] and model predictive control [5] and [6]. In this paper, a new real-time fuzzy logic scheme to control the automatic dry friction clutch is developed to control the engagement of the clutch.

The motivation of using fuzzy logic control in this study is the ability of an intelligent controller based on uncertain and imprecise information. In automotive industry, the successful applications of fuzzy logic to control anti-lock braking system (ABS) can be seen. The control close-loop time for this ABS is about 5 milliseconds. Within this time interval, the micro-controller can collect all sensor data, process and compute the ABS algorithms, drive the bypass valves for the brake fluid, and conduct the brake activities successfully.

In the next section of this paper, a typical parallel hybrid vehicle and clutch engagement model is developed, and then, fuzzy logic control algorithms are formulated. Comprehensive simulations for the hybrid vehicle are then conducted in Matlab 2009a to illustrate the performance of the new controller. Experimental results applied for a real damping clutch to verify and handle the vehicle resonance vibration frequencies are presented. And finally, conclusions and recommendations from the study are drawn.

## II. CLUTCH ENGAGEMENT MODELING

Figure 1 shows the configuration of a very common parallel HEV, which consists of a conventional ICE and two EM1 and EM2. An automatically controllable clutch separates the drivetrain into two parts: part 1 - ICE with EM1, and part 2 - EM2 and the rest of the transmission. EM1 serves as a starter and a generator. This rear wheel is equipped with a standard automated gearbox without a torque converter.

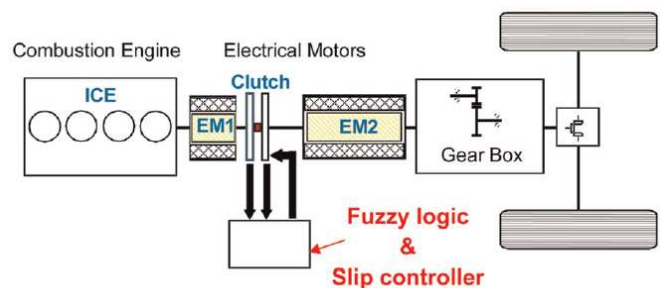

Fig. 1. Configuration of parallel hybrid powertrain

During the pure electrical drive at low speeds (less than 50km/h), the clutch is open and a series hybrid configuration is achieved. In this operating range, the EM2 propels the vehicle. The transmission from series mode to parallel mode takes place at high speeds (more than 50km/h) by closing the clutch. The EM1 activates the ICE to run the vehicle while the EM2 turns off. EM1 then acts as a generator to recharge the battery. During some critical operations, depending on the demand of the driver or during some essential heavy loads or other emergency cases if needed, both EM1 and EM2 can be automatically turned on to assist the ICE to propel the vehicle.

Clutch is one of the most important components in a vehicle drivetrain. Clutch allows the connection and transmission of the driving force from the ICE or EM1 and EM2 to the wheels. The clutch system for this model consists of two dry friction disks connected in the ends of two rotating shafts. One shaft is attached to the ICE or EM1 while the other shaft is connected to the gearbox and the differential gearbox to propel the vehicle.

There are two separate modes of the clutch connections: locked together and rotating at the same angular speed (engaged), or decoupled and rotating in at different angular speed (disengaged). Handling transmission between the two

modes is a major modelling challenge. As the system loses one degree of freedom in the locking up process, the transmitted torque through this process becomes a discontinuity. The magnitude of the torque falls from the maximum value to a lowest value necessary to keep the two disks of the clutch spinning at the same speed. The two dynamic models are used to simulate the locked mode (engaged) and the decoupled mode (disengaged). A switching mechanism is developed to recognize the precise moments of the transitions between the two modes and activate the switches accordingly.

Figure 2 shows a clutch system, where  $M_1$  is the driving torque (input);  $F_{NC}$  is the normal force between friction disks;  $J_1$  and  $J_2$  are moments of inertia;  $k_{\beta 1}$  and  $k_{\beta 2}$  are the damping coefficients in two shafts;  $\mu_K$  and  $\mu_S$  are kinetic and static coefficients of friction;  $\omega_1$  and  $\omega_2$  are angular velocities of the two shafts;  $r_i$  and  $r_o$  are the inner and outer radii of the clutch friction surfaces;  $R_C$  is the clutch equivalent net radius;  $M_2$  is the torque transmitted through the clutch; And  $M_R$  is the torque required for maintaining the locked position.

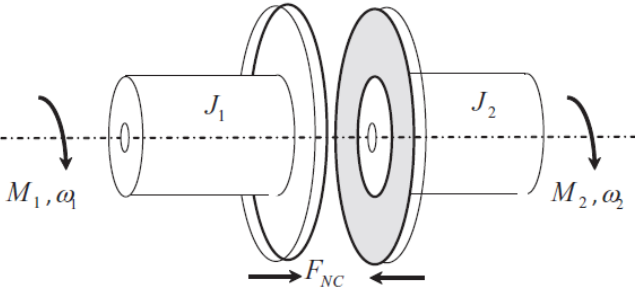

Fig. 2. Clutch system

The dynamic equations for the locked mode are derived as follows:

$$\begin{aligned} J_1 \dot{\omega}_1 &= M_1 - k_{\beta 1} \omega_1 - M_2 \\ J_2 \dot{\omega}_2 &= M_2 - \omega_2 k_{\beta 2} \end{aligned} \quad (1)$$

The full torque capacity in a clutch is a function of its area ( $A_C$ ), friction force ( $F_f$ ), and the corresponding radii ( $r$ ,  $r_o$  and  $r_i$ ):

$$\begin{aligned} T_{f \max} &= \iint_{A_C} \frac{r F_f}{A_C} \partial A_C, \text{ or} \\ T_{f \max} &= \frac{F_{NC} \mu}{\pi(r_o^2 - r_i^2)} \int_{r_i}^{r_o} \int_0^{2\pi} r^2 \partial r \partial \theta, \text{ or} \\ T_{f \max} &= \frac{2}{3} R_C F_N \mu \text{ with } R_C = \frac{(r_o^3 - r_i^3)}{(r_o^2 - r_i^2)} \end{aligned} \quad (2)$$

When the clutch is slipping, the model uses the kinetic friction coefficient ( $\mu_K$ ):

$$T_2^{Slipping} = \text{sgn}(\omega_1 - \omega_2) T_{f \max} = \text{sgn}(\omega_1 - \omega_2) \frac{2}{3} R_C F_{NC} \mu_K \quad (3)$$

When the clutch is locked or  $\omega_1 = \omega_2 = \omega$ , the system acts as single unit and equation (1) can be combined into a single equation for the locked mode:

$$(J_1 + J_2) \dot{\omega} = M_1 - (k_{\beta 1} + k_{\beta 2}) \omega, \quad (4)$$

or

$$M_2^{Locked} = M_f = \frac{J_2 M_1 - (J_2 k_{\beta 1} - J_1 k_{\beta 2}) \omega}{J_2 + J_1} \quad (5)$$

The clutch remains locked until the magnitude of the friction torque ( $M_f$ ) exceeds the static friction capacity ( $M_{f \max}^{Static}$ ):

$$M_{f \max}^{Static} = \frac{2}{3} R_C F_{NC} \mu_S \quad (6)$$

A switching diagram for the clutch activities is illustrated in Figure. 3.

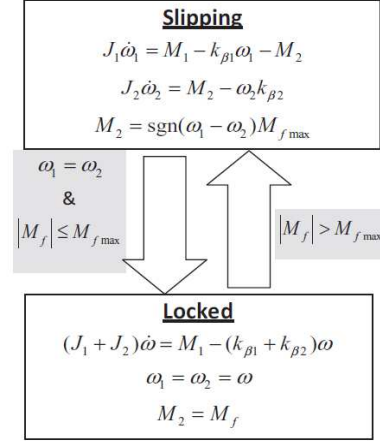

Fig. 3. Friction mode transmissions

In this clutch model, the engine speed rapidly changes and leads to the rapid changes in accelerations and jerks of the vehicle. The engine speed undergoes a rapid change of acceleration as it synchronizes with the drivetrain via the clutch engagement rate. For a low jerk property, it would be better to have the longest possible engagement time and to avoid any sudden step input to the clutch. However, in reality, this is not practical as excessive slipping leads to overheating of the clutch resulting a short operating life. Ideally, any engagement should not last any more than 3 to 4 seconds.

### III. FUZZY LOGIC CONTROL

An automatic controller for the clutch must be designed to perform two operating modes: 1) shifting connections and 2) changing gears. Shifting connection is the mode of the clutch engagement or disengagement depending on the driver intention via the driver action on the engine throttle. Therefore, the controller will determine the shifting connection mode via the position and the rate of the throttle operation. The changing gear mode is selected based on the current torque load and the vehicle velocity matching with the engine speed.

Based on the requirements of the two clutch operating modes, fuzzy logic control rules are selected with the use of slip-feedback regulator. These rules base on the difference between the input and the output speeds of the clutch to create the feedback loop to control the engagement pressure via its slip gains. The clutch slip is simply the speed difference between the input and the output shafts and finally reaching zero when the clutch is locked. The clutch engagement pressure will be regulated proportionally on the slip rate with special notions on this clutch lockup and the idling engine speed.

A set of fuzzy logic algorithms is developed to control the automatic clutch, which can understand the driver intention. For example, an aggressive pressure on the accelerator pedal or a rapid throttle opening rate can be understood that the

driver needs a high pressure ramp rate on the clutch engagement for a short time. While a gradual pressure on the accelerator pedal will lead to a long and smooth clutch engagement period. A fast release of the accelerator pedal leads a fast drop of engine speed and fast reduction of clutch pressure. The clutch is disengaged with negative pressure gain and the engine is running in idling condition. The gear shifting operations are also activated accordingly based on the output torque load and the vehicle speed.

A set of fuzzy logic rules is built with variables for throttle in positions: Closed (< 1%), Narrow (1-25%), Normal (25-85%) and Wide (85-100%) and in rates: Low (<25%/s), Normal (25-85%/s), and High (>85%/s), and variables for engine speed: Very Low (<800rpm or Idling speed), Low (800-2000rpm), Normal (2000-3500rpm), and High (>3500rpm), and for engine speed rate: Dropping Quickly (<-3000rpm/s), Dropping Slightly (-3000-0rpm/s), Stable (0rpm/s), Rising Slightly (0-3000rpm/s), and Rising Quickly (>3000rpm/s).

A fuzzy clutch controller is designed where the clutch pressure is a function of the slip, slip gain, and fuzzy logic rules. Variables for the slip gain of this controller are: Negative (<-0.2), Slightly Negative (<-0.1), Zero (=0), Low (0.025), Normal (0.075), and High (0.2). The fuzzy logic rules for controlling slip gain are as follows:

**Throttle Rules:**

If Throttle is Narrow, or Throttle Rate is Low, then Slip Gain is Low,  
 If Throttle is Normal, or Throttle Rate is Normal, then Slip Gain is Normal,

If Throttle is Wide, or Throttle Rate is High, then Slip Gain is High,

**Stalling Rules:**

If Engine Speed is Dropping Rapidly or is Very Low then Slip Gain is Negative,

If Engine Speed is Dropping Slowly then Slip Gain is Slightly Negative,

If Engine Speed is Stable then Slip Gain is Low,

If Engine Speed is Rising Slowly then Slip Gain is Normal,

If Engine Speed is Rising Rapidly then Slip Gain is High,

**Driver Intention Change and Engine Speed Rules:**

If Throttle is Wide or Throttle Rate is High and Engine Speed is Low, then Slip Gain is Slightly Negative,

If Throttle is Wide or Throttle Rate is High and Engine Speed is Normal, then Slip Gain is Normal,

If Throttle is Wide or Throttle Rate is High and Engine Speed is High, then Slip Gain is High,

If Throttle is Narrow or Throttle Rate is Low and Engine Speed is High, then Slip Gain is High,

If Throttle is Narrow or Throttle Rate is Low and Engine Speed is Normal, then Slip Gain is Normal,

If Throttle is Narrow or Throttle Rate is Low and Engine Speed is Low, then Slip Gain is Low,

If Throttle is Normal or Throttle Rate is Normal and Engine Speed is Normal, then Slip Gain is Normal,

If Throttle is Normal or Throttle Rate is Normal and Engine Speed is High, then Slip Gain is Normal,

If Throttle is Normal or Throttle Rate is Normal and Engine Speed is Low, then Slip Gain is Low,

**Stationary Rule:**

If Throttle is closed then Slip Gain is Zero.

Figure 4 shows a fuzzy logic controller developed in Matlab R2009s. This fuzzy logic controller compiles all data of the throttle position, throttle rate, engine speed, and engine speed rate with the above fuzzy logic rules and then, calculate an engagement gain. The clutch pressure now is a product of slip signal from the speed sensors in the two friction clutch disks and the gain provided from this fuzzy logic controller.

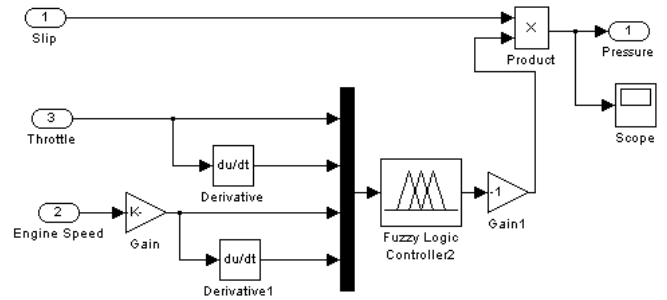

Fig. 4. Fuzzy friction clutch controller

The fuzzy logic surface graphics for the above slip gain rules are shown in Figure 5-7.

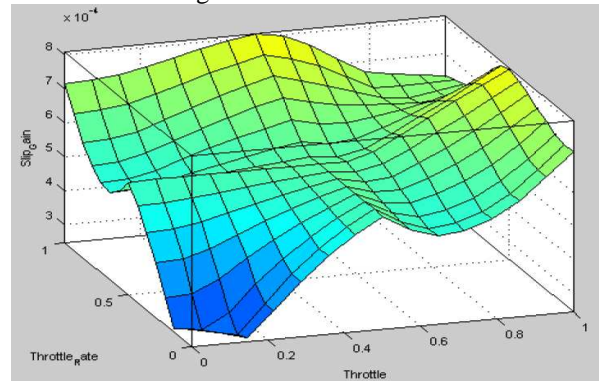

Fig. 5. Fuzzy logic surface throttle against throttle rate

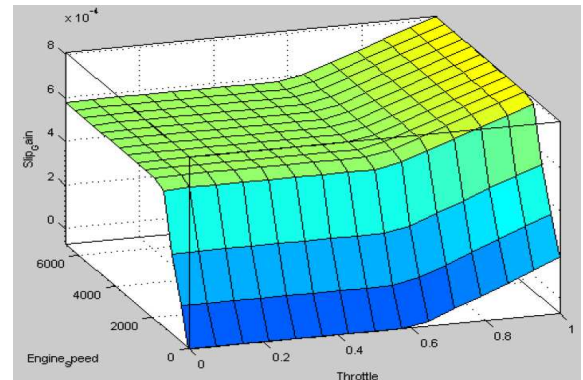

Fig. 6. Fuzzy logic surface throttle against engine speed

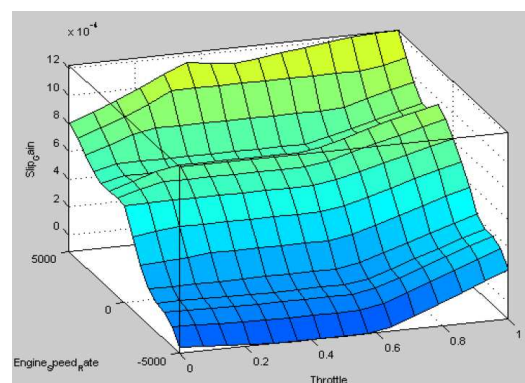

Fig. 7. Fuzzy logic surface throttle against engine speed rate

IV. CLUTCH ENGAGEMENT SIMULATION

A comprehensive HEV model is developed using Matlab Simulink R2009a including all ICE, EM1, EM2, battery, controllable friction clutch, fuzzy logic controller, and vehicle dynamic parts. A system control centre is developed to synchronize the activities of all components as shown in Figure 8.



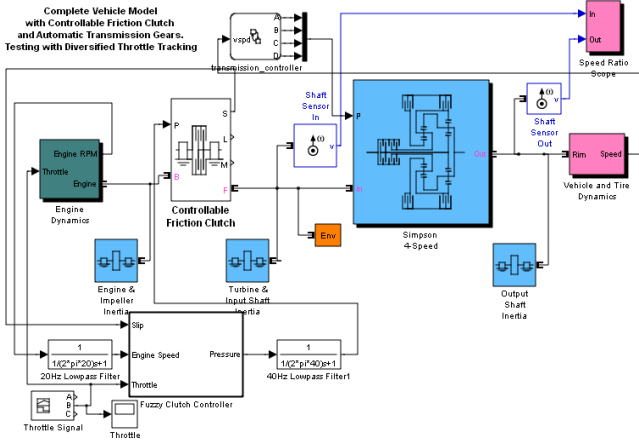

Fig. 8. Comprehensive simulation

Overall simulations are firstly tested for the hybrid vehicle with an automatic transmission gearbox (Simpson 4 speeds) having the gear ratios of Gear 1: 2.393; Gear 2: 1.450; Gear 3: 1.000; and Gear 4: 0.677, and compared with the performance of a torque converter for a rapid full throttle opening in 3 seconds and then, slow throttle closing. Figure 9 shows that the automatic friction clutch provides faster and smoother gear shifting and leads to a higher vehicle speed due to the higher efficiency of the torque transmission (97% to 86%). But when we release the accelerator pedal and close the throttle, the automatic friction clutch disengaged instantaneously and completely, the vehicle speed is reducing slower than that of the torque converter. That can be used to save more energy for the hybrid vehicle to recharge the battery.

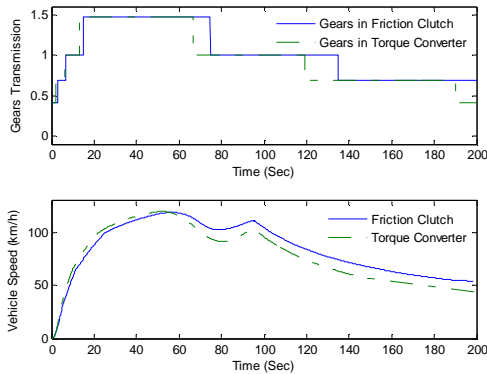

Fig. 9. Automatic gear shifting and vehicle speed

In figure 10, hybrid vehicle was tested by maintaining a fully open throttle for 100 seconds. It can be seen that the slip rates for the automatic friction clutch are higher in the starting period due to the torque converter providing a better fluid damping. However, when reaching stability, the slip of the torque converter is considerably higher than that of the friction clutch (7% to 3%) due to the higher efficiency of dry friction clutch. That leads to a higher vehicle speed for this automatic dry friction clutch over the torque converter.

A test result for the performance of fuzzy logic controller is shown in figure 11 where the throttle positions were varied with different rates. The throttle is aggressively opened from 0-100% in 3 seconds, then maintained for 50 seconds, then gradually closed in 20 seconds, then re-opened in 20 seconds, then again maintained for another 10 seconds, and finally closed at a fast rate. The clutch forces are regulated accordingly based on the gain determined from the fuzzy logic rules.

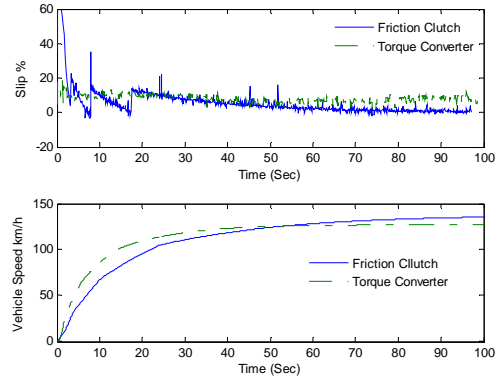

Fig. 10. Clutch slip and vehicle speed

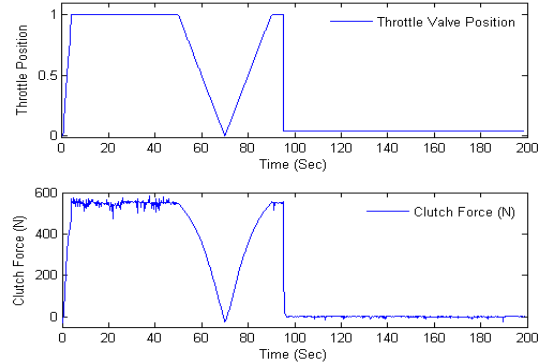

Fig. 11. Performance of automatic clutch controller

Simulations with fuzzy logic algorithms show that the clutch controllers can understand well the driver intention. An aggressive pressure on the accelerator pedal or a rapid throttle opening rate leads to a high pressure ramp rate on the clutch engagement for a short time. While a gradual pressure on the accelerator pedal initiates a long and smooth clutch engagement period, A fast release of the accelerator pedal results to a fast drop of in the engine speed and the fast reduction of the clutch pressure. Finally, the clutch is disengaged with negative pressure gain and the engine is running in idling speed.

## V. RESULTS OF RESONANCE VIBRATION REDUCTION

Vibration reduction on the clutch transmission can be achieved by increasing the system damping and/or adjusting the clutch pressure. This is a description of the experimental results from a real vehicle tested with an automatic dry friction clutch in a Honda Civic of 1.6L gasoline engine and 5-speed automation manual transfer (AMT), where the clutch pressures are controlled and adjusted via a microprocessors and PID controller as shown in figure 2.1. The critical vibration is found at the engine speed of 1860 rpm or at frequency of 31 Hz when passing through the respective load ranges (Figure 12).

At this critical frequency, the clutch pressure is regulated (slightly released) in order to vary the clutch slip from 1-5%. A considerable reduction of the critical vibration is observed when the clutch slip is released at a value of 2.5% as seen in figure 13.

Figure 14 indicates that the completed clutch engagement is achieved at approximately 0.7 seconds resulting in the drive shaft torque being sufficiently smooth with no oscillations or sudden drops. It is noticed that the controller is very sensitive to variations of the clutch friction coefficient and the clutch pressure. Any reduction of vibrations in the

clutch pressure will lead to the reduction in vibrations of the transmission torque resulting in the clutch failing to lock-up in steady-state.

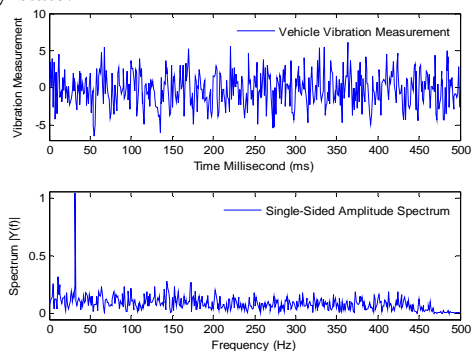

Fig. 12. Amplitude Spectrum of Vehicle Noise Measurement

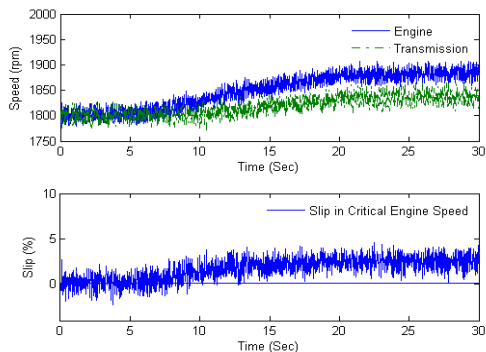

Fig. 13. Speed and slip in the clutch at critical frequency

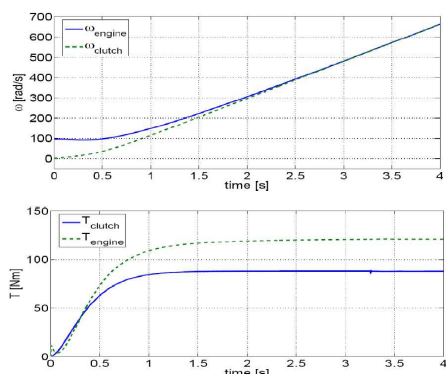

Fig. 14. Clutch engagement and transmission torque

Another solution to deal with the critical vibrations is to raise the system damping or to use the vibration eliminators. In this experimental test, some vibration eliminators with special design for elimination of the critical vibration amplitudes are employed (Figure 15). In this simple design, disks were added with higher damping characteristics to absorb the vibrations.

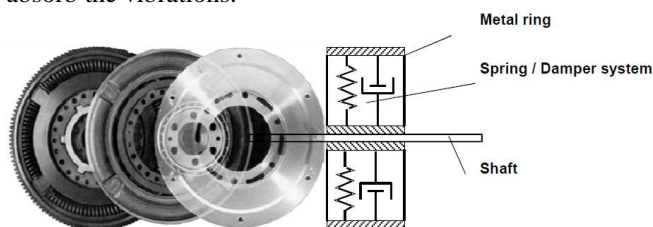

Fig. 15. Clutch with vibration eliminators

The vibration eliminators can reduce 80% of vibration amplitude for high frequencies above 60 Hz (Figure 16). Using new linings of sintered metal, ceramics, or fibre-reinforcement plastics, the negative effects can be

compensated on the clutch life when increasing the slip value. However, the increase in fuel consumption due to this application has not been determined yet.

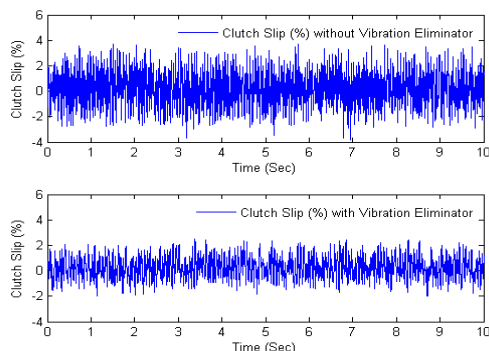

Fig. 16. Performance of clutch with vibration eliminators

In critical high frequencies, the clutch with these vibration eliminators can introduce higher levels on comfort. For this special clutch, the elastic coupling of additional disks achieves an extensive elimination of the emergence of resonance. The main disadvantages of this clutch are higher expense and larger space. Therefore, this kind of clutch can be applied only for the rear-wheel driven HEVs due to the limited available space for the front-wheel drive vehicles. The more complex clutch also leads to the higher maintenance cost.

## VI. CONCLUSIONS

The fuzzy logic control rules for an automatic friction clutch of hybrid vehicle have been developed and tested. The new system can control the slip and offer fast engagements in low jerk and high comfort. Experimental results show that regulating the clutch pressure and increasing the clutch damping characteristics can achieve the vibration reduction in critical frequencies. The paper has offered useful contributions to the development of HEVs. The control schemes can be used in electronic control units for real HEVs applications.

## ACKNOWLEDGMENT

This research was supported by the Department of Mechatronics, Faculty of Mechanical Engineering, Tallinn University of Technology.

## REFERENCES

- [1] Minh VT. "Clutch control and vibration reduction for a hybrid electric vehicle," *Journal of Systems and Control Engineering*, ISSN: 0959-6518, accepted 2012.
- [2] Schouten NJ, Salman MA and Kheir NA. "Fuzzy logic control for parallel hybrid vehicles," *IEEE Trans Control Systems Technology* 2002; 10(3): 460–468.
- [3] Kim TS, Manzie C and Sharma R. "Model predictive control of velocity and torque split in a parallel hybrid vehicle," *Proceedings of the IEEE international conference on systems*, San Antonio, TX, October 2009, ISSN: 1062-922X, pp.2014–2019.
- [4] Paganelli G, Delprat S, Guerra TM, et al. "Equivalent consumption minimization strategy for parallel hybrid powertrains," *Proceedings of the IEEE vehicular technology conference*, Taipei, Taiwan, May 2002, ISSN: 1550-2252, pp.2076–2081.
- [5] Sciarretta A, Back M and Guzzella L. "Optimal control of parallel hybrid electric vehicles," *IEEE Trans Control Systems Technology* 2004; 12(3): 352–363.
- [6] Minh VT, Hashim FB and Awang M. Development of a real-time clutch transition strategy for a parallel hybrid electric vehicle. *Journal of Systems and Control Engineering*, 2012, vol. 226(12), pp. 188-203.